

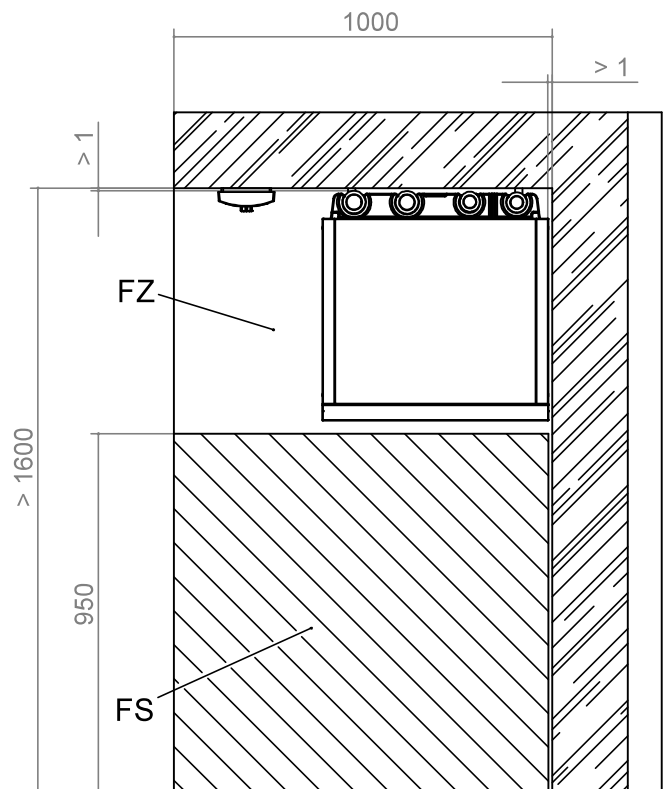

SICV 6.2(H)(K)3 – SICV 16.2(H)(K)3

Aufstellungsplan 1

V1

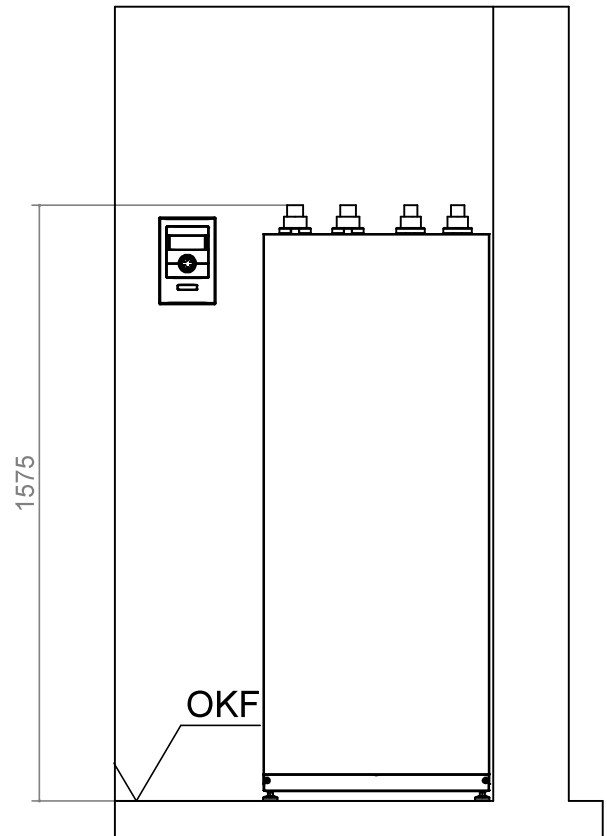

Legende: DE819465

Alle Maße in mm.

V1	Version 1	FS	Freiraum für Servicezwecke
OKF	Oberkante Fertigfußboden	FZ	Freiraum für funktionsnotwendiges Zubehör



Aufstellungsplan 2

SICV 6.2(H)(K)3 – SICV 16.2(H)(K)3

V2

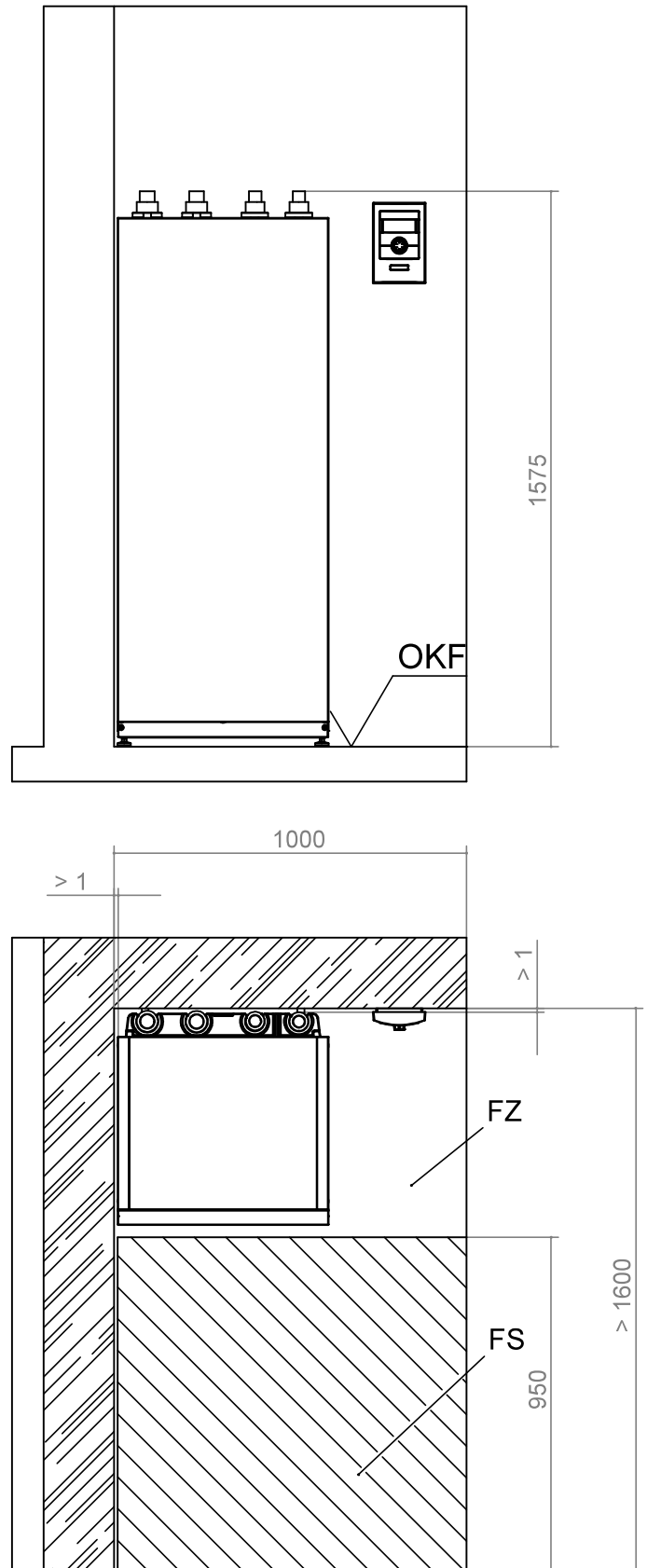

Legende: DE819465

Alle Maße in mm.

V2	Version 2	FS	Freiraum für Servicezwecke
OKF	Oberkante Fertigfußboden	FZ	Freiraum für funktionsnotwendiges Zubehör



V3

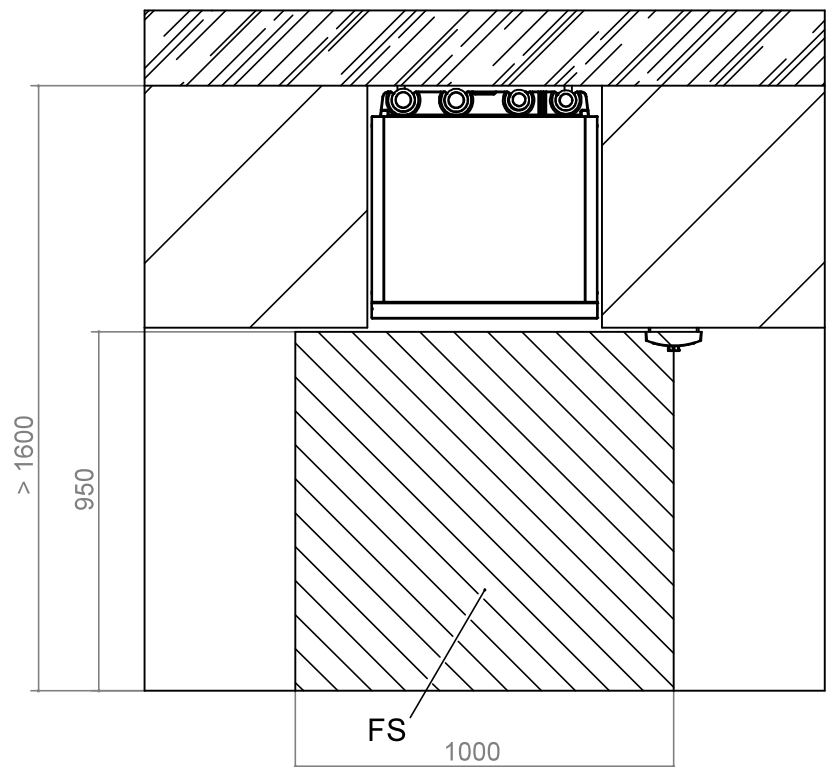
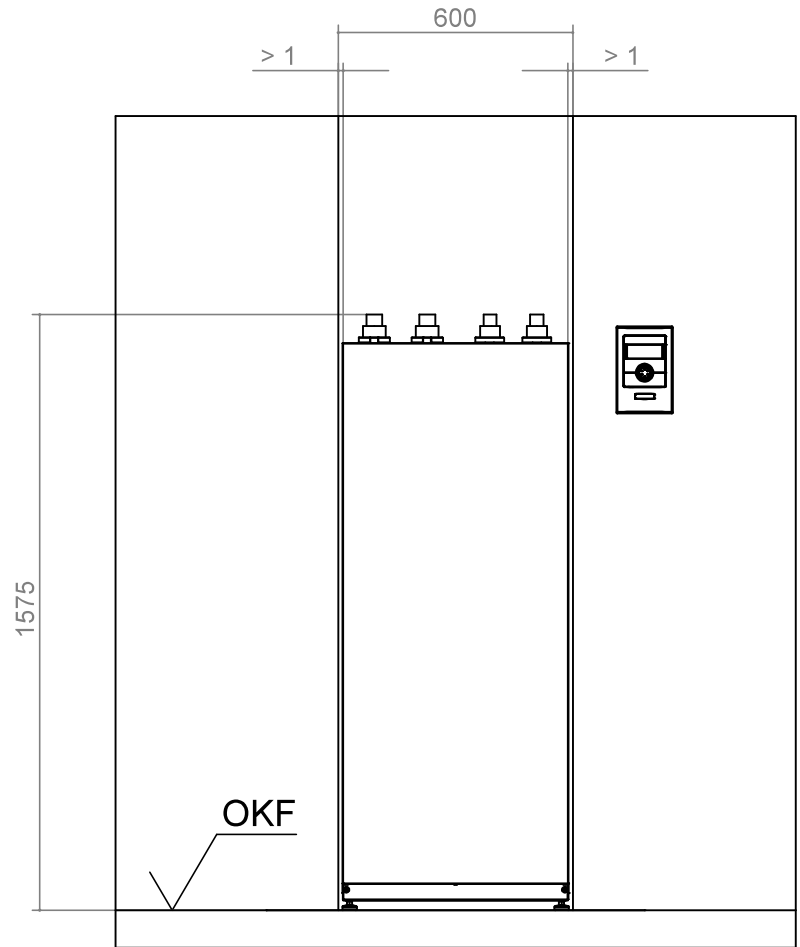

Legende: DE819465

Alle Maße in mm.

V3 | Version 3

OKF | Oberkante Fertigfussboden

FS | Freiraum für Servicezwecke



Hydraulische Einbindung (Heizen)

Gerätevariante H

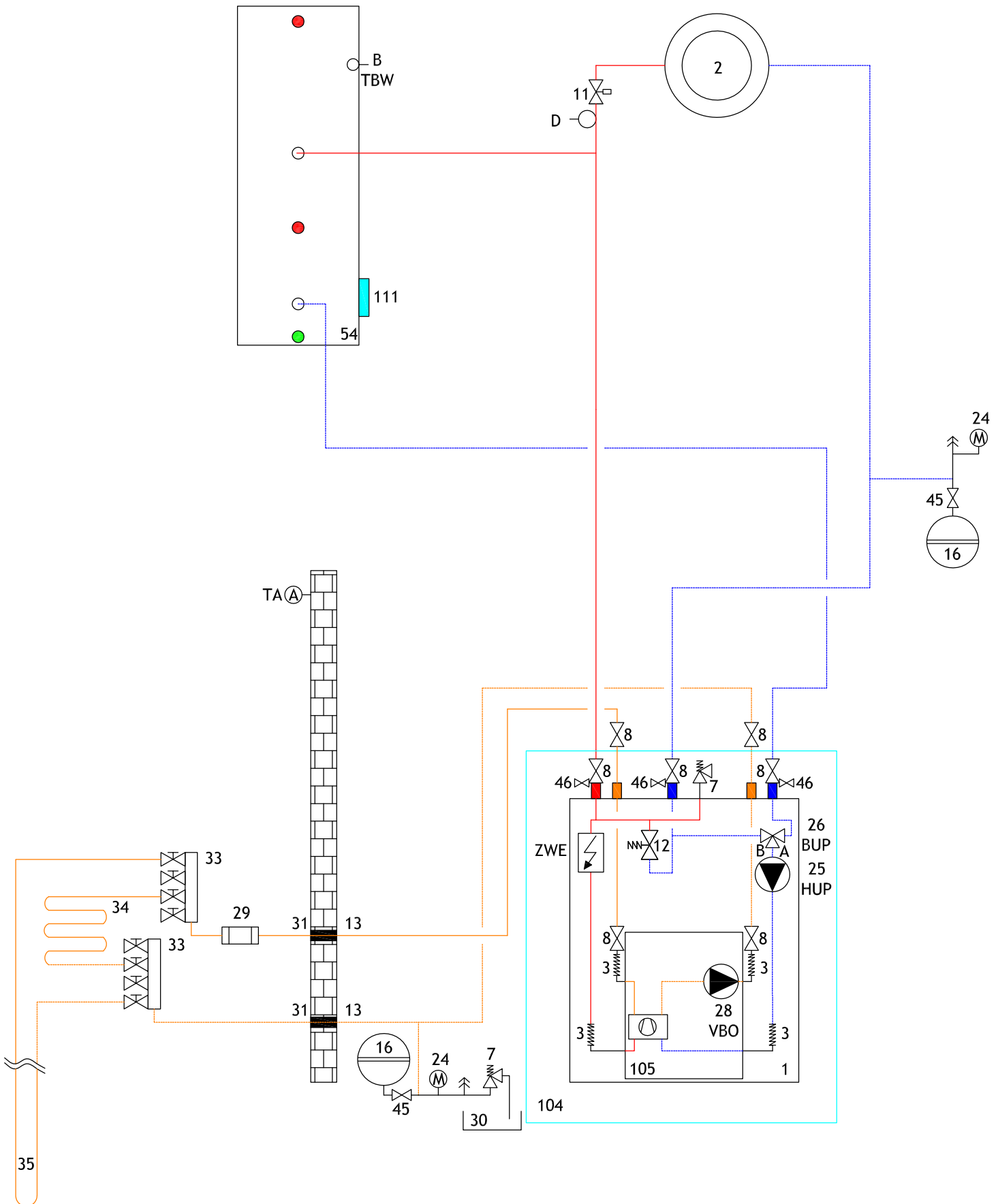



Gerätevariante H

mit Trennpufferspeicher

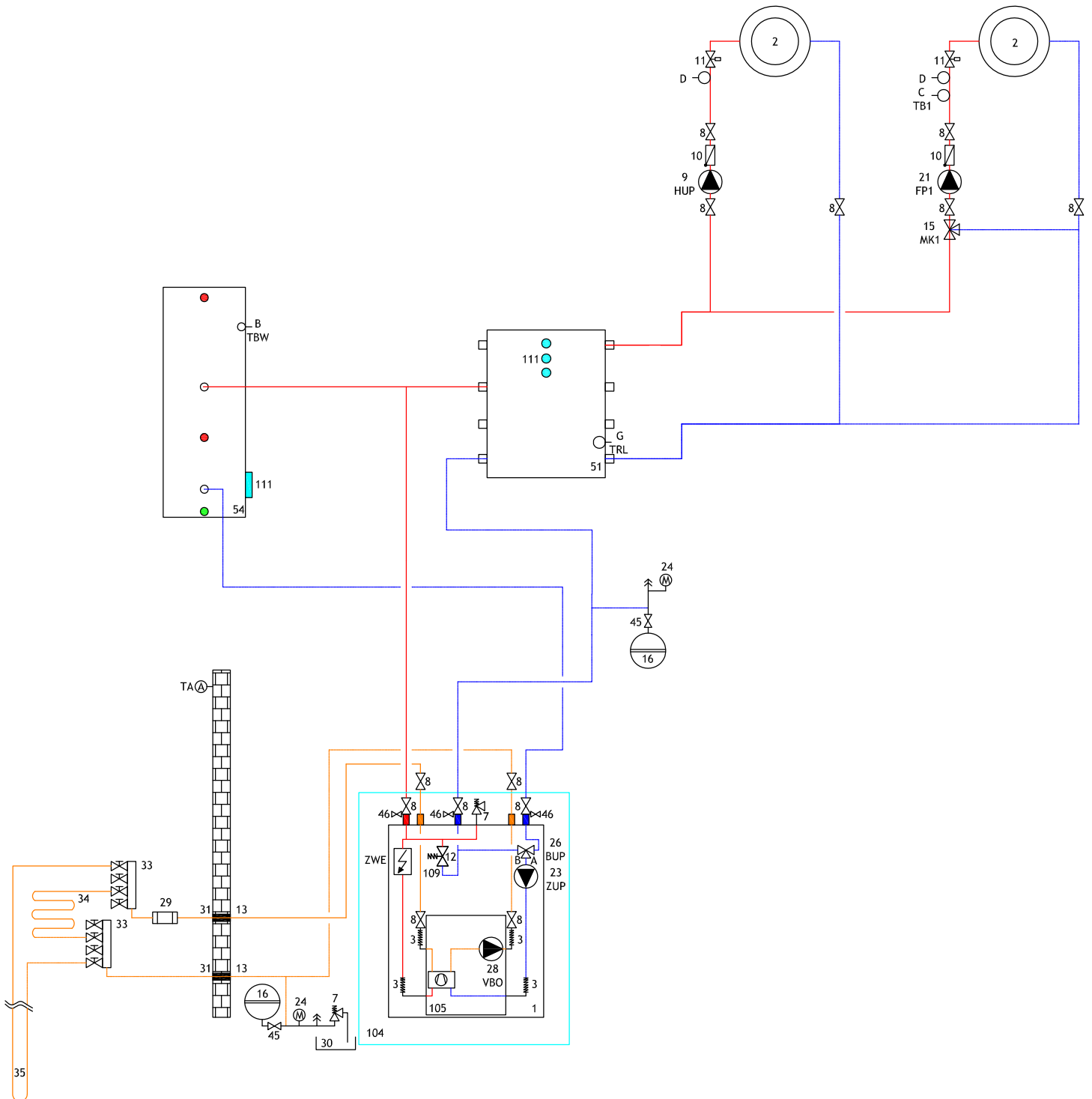



Hydraulische Einbindung (Kühlung)

Gerätevariante K

